

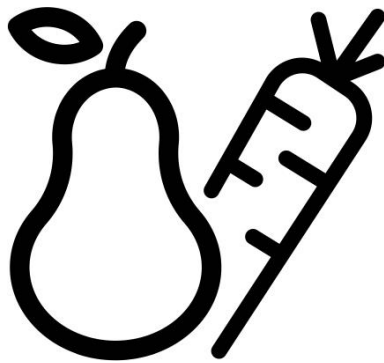

# Multimode

Instruction for use



**AL 235 JOKER 7515220030**

EN



## WARNING!

In order to ensure a normal operation of your refrigerating appliance, which uses a completely environmentally friendly refrigerant the R600a (flammable only under certain conditions) you must observe the following rules:

- ♦ Do not hinder the free circulation of the air around the appliance.
- ♦ Do not use mechanical devices in order to accelerate the defrosting, others than the ones recommended by the manufacturer.
- ♦ Do not destroy the refrigerating circuit.
- ♦ Do not use electric appliances inside the food keeping compartment, other than those that might have been recommended by the manufacturer.

## INFORMATION

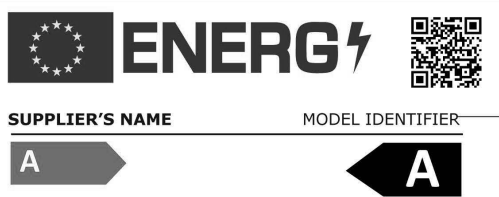

The model information as stored in the product data base can be reached by entering following website and searching for your model identifier (\*) found on energy label.

<https://eprel.ec.europa.eu/>

## EN

## Content

Advice for recycling of the old appliance	/ 1
Packing Recycling	/ 2
Transport instructions	/ 2
Warnings and special advice	/ 2
Setting up	/ 3
Electric connection	/ 3
Switching off	/ 4
Operation	/ 4
Appliance description	/ 4
Appliance operation (multimode)	/ 4
Advice for food conservation	/ 5
Changing the illumination lamp	/ 6
Mounting of the water collection tray	/ 6
Way of energy saving	/ 6
Advice to defrost your appliance	/ 6
Cleaning of the appliance	/ 6
Defects finding guide	/ 7

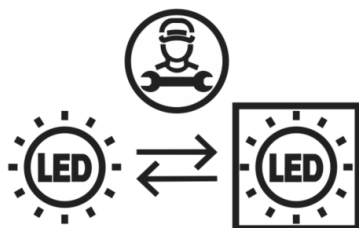

This product is equipped with a lighting source of the "G" energy class. The lighting source in this product shall only be replaced by professional repairers.

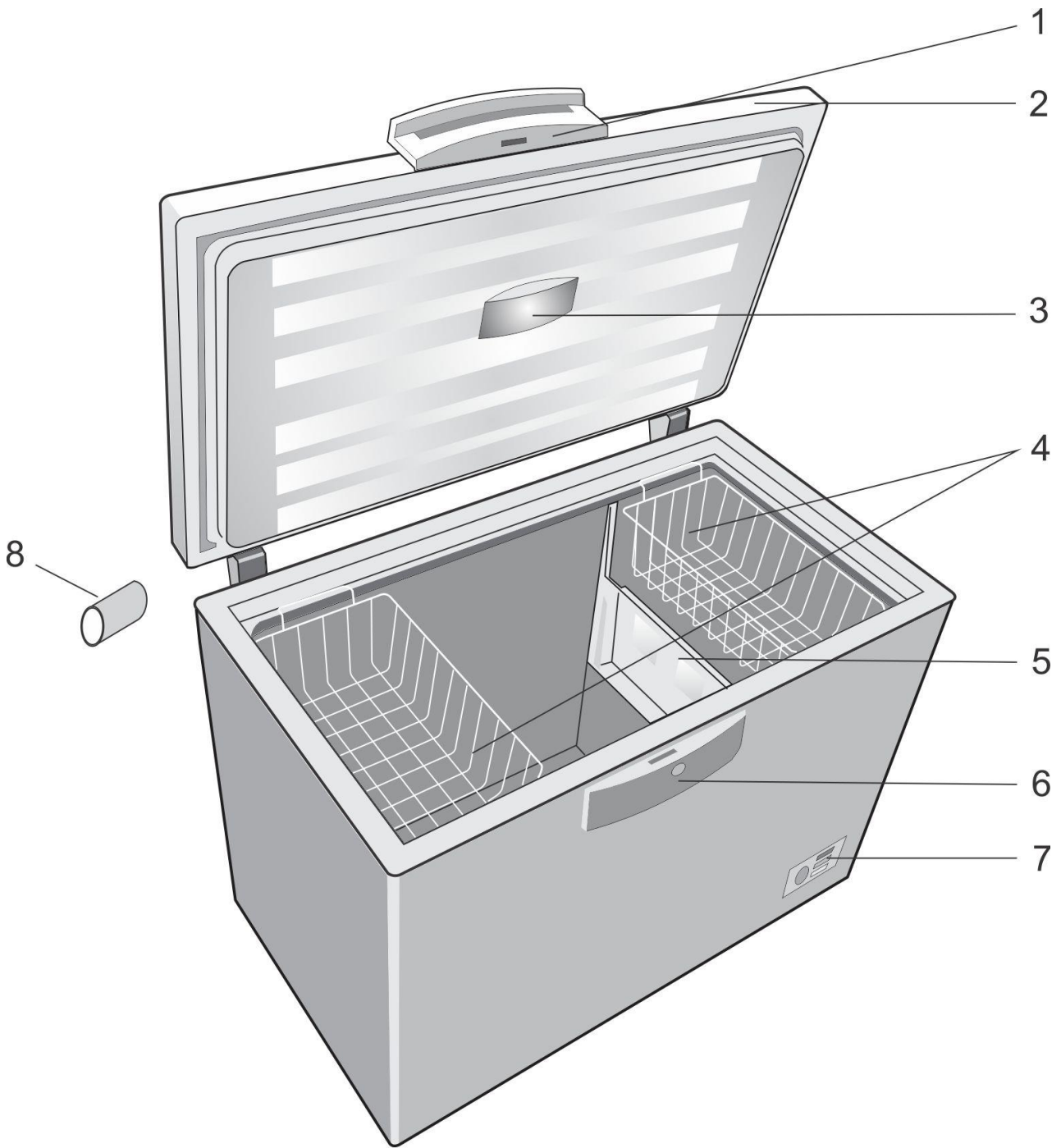

Item 1

**i** Figures that take place in this instruction manual are schematic and may not correspond exactly with your product. If the subject parts are not included in the product you have purchased, then it is valid for other models.

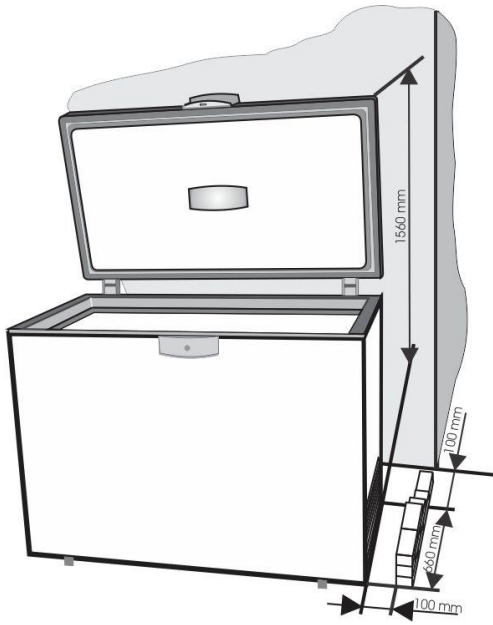

Item 2

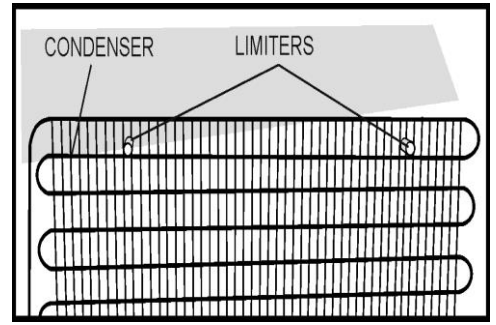

Item 3

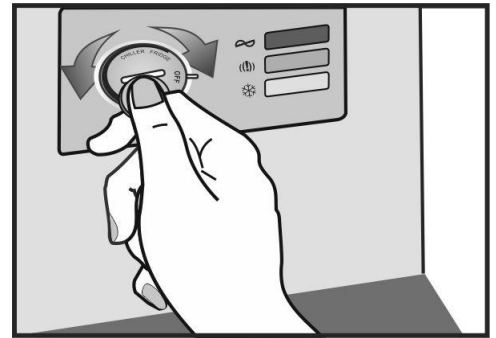

Item 4

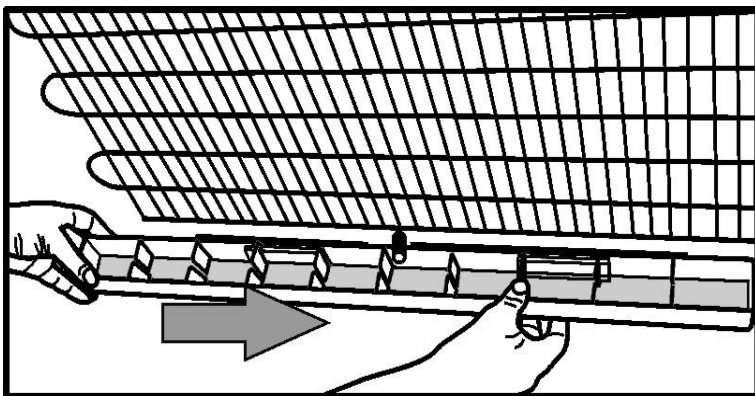

Item 6

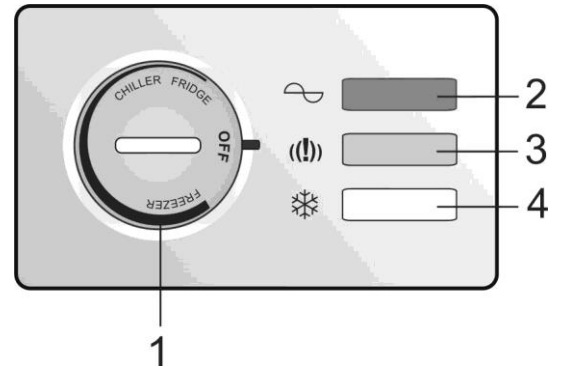

Item 5

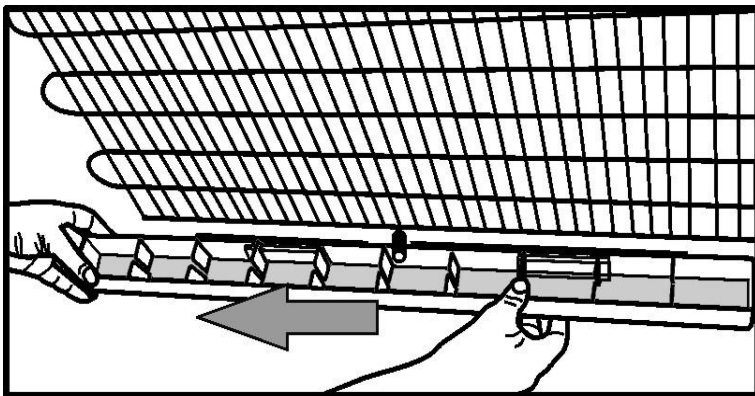

Item 7

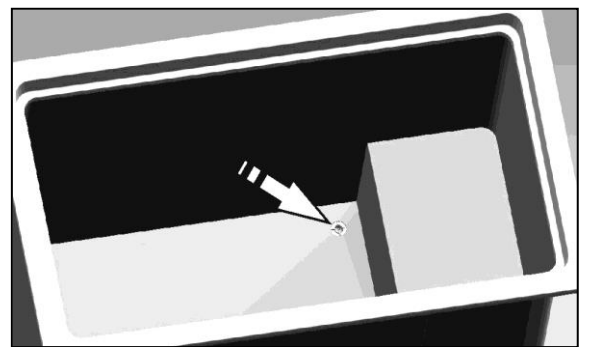

Item 8

## **Congratulations for your choice!**

The appliance you have purchased is one in the **ALTUS** products range and represents a harmonious joining between the refrigeration technique with the aestetical outlook. It has a new and attractive design and is built according to the European and national standards which guarantee its operation and safety features. At the same time, the used refrigerant, R600a, is environment-friendly and it does not affect the ozone layer.

In order to use the best your appliance, we advise you to read carefully the information in these user instructions.

### ***Advice for recycling your old appliance***

If your newly purchased appliance replaces an older appliance, you must consider a few aspects.

The old appliances are not valueless scrap. Their disposal, while preserving the environment, allows the recovery of important raw materials.

Make your old appliance useless:

- disconnect the appliance from the supply;
- remove the supply cord (cut it);
- remove the eventual locks on the door to avoid the blocking of children inside, while playing, and the endangering of their lives.

The refrigerating appliances contain insulating materials and refrigerants which require a proper recycling.

Original Spare parts will be provided for 10 years, following the product purchasing date.

**This appliance is not intended for use by person with reduced physical, sensory or mental capabilities or lack of experience and knowledge unless they have been given supervision or instruction concerning use of the appliance by a person responsible for their safety.  
Children should be supervised to ensure that they do not play with the appliance.**

## ***Packing Recycling***

### ***WARNING!***

**Do not allow children to play with the packing or with parts of it. There is the risk of suffocation with parts of corrugated cardboard and with plastic film.**

In order to get to you in good condition, the appliance was protected with a suitable packing. All the materials of the packing are compatible with the environment and recyclable. Please help us recycle the packing while protecting the environment!

### ***IMPORTANT!***

Before putting the appliance in operation, read carefully and entirely these instructions. They contain important information concerning the setting up, use and maintenance of the appliance.

The manufacturer is free of any responsibility if the information in this document are not observed. Keep the instructions in a safe place in order to reach them easily in case of need. They can also be useful subsequently by another user.

### ***ATTENTION!***

**This appliance must be used only for its intended purpose, (household use), in suitable areas, far from rain, moisture or other weather conditions.**

## ***Transport instructions***

The appliance must be transported, as much as possible, only in vertical position. The packing must be in perfect condition during transport.

If during transport the appliance was put in horizontal position (only according to the markings on the packing), it is advised that, before putting it into operation, the appliance is left to rest for 4 hours in order to allow the settling of the refrigerating circuit.

The failure to observe these instructions can cause the breakdown of the motorcompressor and the cancellation of its warranty.

## ***Warnings and general advice***

- Do not plug in the appliance if you noticed a failure.
- Please avoid to distort the refrigerating circuit (tubes) during transport, handling and positioning of the appliance.
- The repairs must be done only by qualified personel.
- In the following situations please unplug the appliance from the mains:
  - when you defrost completely the appliance;
  - when you clean the appliance.

### **To unplug the appliance, pull by the plug, not by the cable!**

- Ensure the minimum space between the appliance and the wall against which it is placed.
- Do not climb on the appliance.
- Do not allow the children to play or hide inside the appliance.
- Never use electric appliances inside the appliance, for defrosting.
- Do not use the appliance near heating appliances, cookers or other sources of heat and fire.
- Do not leave the appliance door open more than it is necessary to put in or take out the food.
- Do not leave the food in the appliance if it is not working.
- Do not keep inside products containing flammable or explosive gases.
- Never touch cold metal parts or frozen food with wet hands because your hands can quickly freeze on the very cold surfaces.
- Verify the horizontal position of the product to ensure a good flow of the water resulted during functioning.

- If you do not use your appliance for a few days, it is not advisable to switch it off. If you do not use it for a longer period, please proceed as follows:
  - unplug the appliance;
  - empty the appliance;
  - defrost it and clean it;
  - leave the door open to avoid the formation of unpleasant smells.
- If the supply cord is damaged, it must be replaced by the manufacturer, its service agent or similarly qualified persons in order to avoid a hazard.
- If your appliance has a lock, keep it locked and store the key in a safe place, out of the reach of children. If you are discarding an appliance with lock, make sure that, is made ineffective. This is very important so as to avoid children being trapped inside, which may cause their loss of life.

### Setting up

This appliance was designed to operate at an ambient temperature between +10°C and +40°C. If the ambient temperature is above +40°C, inside the appliance the temperature can increase.

Set up the appliance far from any source of heat and fire. Placing it in a warm room, the direct exposure to sunbeams or near a heat source (heaters, cookers, ovens), will increase the energy consumption and shorten the product life.

- Please observe the following minimum distances:
    - 100 cm from the cookers working with coal or oil;
    - 150 cm from the electric and gas cookers.
  - Ensure the free circulation of the air around the appliance, by observing the distances shown in Item 2.
- Assemble on the condenser (in the rear side) the supplied spacers (Item 3).
- Place the appliance in a perfectly even, dry and well ventilated place.
- Assemble the supplied accessories.

### Electric connection

Your appliance is intended to operate at a single-phase voltage of 230V/50 Hz. Before plugging in the appliance, please make sure that the parameters of the mains in your house (voltage, current type, frequency) comply to the operation parameters of the appliance.

- The information concerning the supply voltage and the absorbed power is given on the marking label placed in the back side of the appliance.
- The electric installation must comply with the law requirements.
- **The earthing of the appliance is compulsory. The manufacturer has no responsibility for any damage to persons, animals or goods which may arise from the failure to observe the specified conditions.**
- The appliance is endowed with a supply cord and a plug (European type, marked 10/16A) with double earthing contact for safety. If the socket is not the same type with the plug, please ask a specialised electrician to change it.
- Do not use extension pieces or multiple adapters.
- Please keep a distance of min. 25 cm from any furniture „suspended” above the appliance. This clearance will also be kept in case of a niche or of another construction element.
- The appliance is not built to be included into the furniture.
- Please fit the supplied accessories.

## Switching off

The switching off must be possible by taking the plug out of the socket or by means of a mains two-poles switch placed before the socket.

## Operation

Before putting into operation, clean the inside of the appliance (see chapter „Cleaning“). After finishing this operation please plug in the appliance and switch on.

The green and red LEDs in the signalling block must light.

Leave the appliance work for about 2 hours without putting food inside it.

## Appliance description

(Item. 1)

1. Door handle
2. Door
3. Lamp housing
4. Baskets
5. Tray
6. Lock housing
7. Thermostat box
8. Spacer for transport

## Appliance operation (multimode)

### Temperature adjustment

The temperature in the cabinet may be adjusted by turning the knob slightly left or right in each function sector. To left for higher temperature and to right for lower temperature.

The achieved temperatures can vary according to the conditions of use of the appliance, such as: place of the appliance, ambient temperature, frequency of door opening, extent of filling with food of the appliance. The position of the thermostat knob will change according to these factors.

The appliance is designed to operate in three ways.

It can operate as a:

1. Refrigerator;
2. Chiller;
3. Freezer.



### Using the unit as a refrigerator

At the refrigerator setting on the knob, the temperature in the cabinet will be about 5°C. This temperature is ideal for storing perishable foods such as dairy products, fresh vegetables and cold meats.



Cold drinks can also be stored at this temperature. The load can be introduced gradually in quantities not bigger than 50kg or 50l, on intervals of 15-20 hours.

### Using the unit as a chiller

At the chiller setting on the knob, the unit may be compared with a butcher's cold storage facility. The temperature in the cabinet can range from 3°C to -2°C. This temperature is ideal for storing meat or fish for short period.



The advantage is that the food can be cooked without first defrosting it. The load can be introduced gradually in quantities not bigger than 50kg or 50l, on intervals of 15-20 hours.

### Using the unit as a freezer

At the freezer setting on the knob the temperature in the cabinet will be around -18°C.

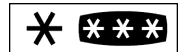

This temperature is ideal for storing frozen foods for long periods of time. For freezing of the fresh food it is possible after min. 20 hours of operation.

In Freezer operation mode is necessary to use the obstructing plug (item 8.)

In Fridge and chiller operation mode the obstruction plug (item 8.) will be removed.

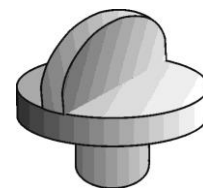



The **signalling system** is placed on the front side of the appliance (Item 5).

It includes:

1. Thermostat adjustment knob – the inside temperature is adjusted.
2. green LED – shows that the appliance is supplied with electric energy.
3. red LED – damage – lights if the temperature in the compartment is too high. The LED will operate 15-45 minutes after the putting into operation of the appliance, then it must go off. If the LED goes on during the operation, this means that defects have occurred.
4. orange LED indicates that the compressor is running.

The three LEDs give information about the mode of operation of the appliance.

### ***Advice for food conservation***

#### **Fridge & chiller operation.**

Avoid a position of the thermostat box outside the ranges "Fridge" & "Chiller" which could lead to negative operation temperatures of the appliance, in this way exceeding temperatures below the intended range, with the danger of the freezing of the beverages and of the fresh food, and excessive build-up of ice on the walls of the cabinet liner. You do not need to remove these drops, because the water which results is collected by the special channel in a small tray placed on the rear side of the appliance, from where it evaporates.

#### **Freezer operation.**

The freezer is intended to keep the frozen food for a long time, as well as to freeze fresh food.

One of the main elements for a successful food freezing is the packing.

The main conditions that the packing must fulfill are the following: to be airtight, to be inert towards the packed food, to resist to low temperatures, to be proof to liquids, grease, water vapours, smells, to be able to be washed.

These conditions are fulfilled by the following types of packings: plastic or aluminium film, plastic and aluminium vessels, waxed cardboard glasses or plastic glasses.

#### ***IMPORTANT!***

- For freezing the fresh food please use the supplied baskets of the appliance.
- Do not place into the freezer a too large quantity of food at a time. The quality of the food is best kept if they are deeply frozen as quickly as possible. This is why it is advisable not to exceed the freezing capacity of the appliance specified in the "Product Fiche".
- The fresh food must not come into contact with the food already frozen.
- The frozen food you have bought can be placed into the freezer without having to adjust the thermostat.
- If the freezing date is not mentioned on the packing, please take into consideration a period of max. 3 months, as a general guide.
- The food, even partially defrosted, cannot be frozen again, it must be consumed immediately or cooked and then refrozen.
- The fizzy drinks will not be kept in the freezer.
- In case of a power failure, do not open the door of the appliance.

### ***Changing the illumination lamp***

To change the Bulb/LED used for illumination of your refrigerator, call your Authorised Service.

The lamp(s) used in this appliance is not suitable for household room illumination. The intended purpose of this lamp is to assist the user to place foodstuffs in the refrigerator/freezer in a safe and comfortable way.

The lamps used in this appliance have to withstand extreme physical conditions such as temperatures below -20°C.

### ***Mounting of the water collection tray***

The tray for the water collection, (delivered with the appliance) must be mounted in the rear of it, under the condenser, on the metal fixing part. It is mounted on the eyes of the metal parts by its displacement in the direction shown by the arrow (Item 6). The tray will be detached from the fixing part if you want to move the appliance from one place to another, mounting it back after moving (Item 7).

### ***Way of energy saving***

- Avoid to place the appliance in a sunny place or near a heat source.
- Provide the good ventilation of the compressor and condenser.
- Do not leave the door open more than necessary and open it only when it is required.
- Keep the condenser clean (the piping at the rear of the appliance).
- For the most efficient operation try to maintain an ambient below 27°C and 65% RH (Relative Humidity)".

### ***Advice to defrost your appliance***

#### **Fridge & Chiller operation.**

The defrosting of your appliance in Fridge or Chiller operation is completely automatic and it occurs during each period of stop of the motor-compressor controlled by the thermostat. No intervention from you is necessary. The water from the defrosting is collected in the water collection tray placed in the rear of the appliance, from where it evaporates.

#### **Freezer operation.**

- We advise you to defrost the freezer at least twice a year or when the ice layer has an excessive thickness.
- The ice build-up is a normal phenomenon.
- The quantity and the rapidity of ice build-up depends on the ambient conditions and on the frequency of the door opening.
- We advise you to defrost the appliance when the quantity of frozen food is the least.
- Before defrosting, adjust the thermostat knob to a higher position of the "Freezer" mode so that the food stores more cold.

- Unplug the appliance.
  - Take out the frozen food, wrap it in several sheets of paper and put them in refrigerator or a cool place.
  - In defrosting period if a large amount of ice is present please check in the rear of the appliance the level of the water in the water tray (Item 6.). In case of exceeding the maximum capacity of the water tray detach it in order to remove the collected water then mount the tray again.
  - For a fast thaw please leave the door open.
- Do not use sharp metal objects to remove the ice.**
- Do not use hairdryers or other electric heating appliances for defrosting.**

### ***Inside cleaning***

Before starting the cleaning, unplug the appliance from the mains.

- It is advisable to clean the appliance when you defrost it.
- Wash the inside with lukewarm water where you add some neutral detergent. Do not use soap, gasoline or acetone which can leave a strong odour.
- Wipe with a wet sponge and dry with a soft cloth.

During this operation, avoid the excess of water, in order to prevent its entrance into the thermal insulation of the appliance, which would cause unpleasant odours.

Do not forget to clean also the door gasket especially the bellow ribs, by means of a clean cloth.

### Outside cleaning

- Clean the outside of the cooler by means of a sponge soaked in soapy warm water, wipe with a soft cloth and dry.
- The cleaning of the outside part of the refrigerating circuit (motorcompressor, condenser, connection tubes) will be done with a soft brush or with the vacuum-cleaner. During this operation, please take care not to distort the tubes or detach the cables.

#### **Do not use scouring or abrasive materials!**

- After having finished the cleaning, replace the accessories at their places and plug in the appliance.
- The tray will be cleaned every time when it is required.

**Attention:** The cleaning will be done with the tray detached from the appliance. After having finished the cleaning, put the accessories back to their places.

### Defects finding guide

#### **The appliance does not work.**

- There is a power failure.
- The plug of the supply cord is not inserted well into the socket.
- The fuse is blown.
- The thermostat is in „**OFF**” position.

#### **The temperatures are not low enough** (red LED on).

- The food prevents the door closing.
- The appliance was not placed correctly.
- The appliance is placed too close to a heat source.
- The thermostat knob is not in the correct position.

#### **Excessive ice build-up in freezer mode.**

- The door was not closed properly.

#### **The inside lighting does not work**

- The lamp is blown. Call your Authorised Service.

#### **The following are not defects.**

- Possible noddings and cracks coming from the product: circulation of the refrigerant in the system.

### Noises during operation

In order to keep the temperature at the value you have adjusted, the compressor of the appliance starts periodically.

The noises which can be heard in such situation are normal.

They are reduced as soon as the appliance reaches the operation temperature.

The humming noise is made by the compressor. It can become a little stronger when the compressor starts.

The bubbling and gurgling noises coming from the refrigerant circulating in the pipes of the appliance, are normal operating noises.

#### **Warning!**

Never try to repair yourself the appliance or its electric components. Any repair made by an unauthorised person is dangerous for the user and can result in the warranty cancellation.



The symbol  on the product or on packaging indicates that this product may not be treated as household waste. Instead it shall be handed over to the applicable collection point for the recycling of electrical and electronic equipment. By ensuring this product is disposed of correctly, you will help prevent potential negative consequences for the environment and human health, which could otherwise be caused by inappropriate waste handling of this product. For more detailed information about recycling of this product, please contact your local city office, your household waste disposal service or the shop where you purchased the product.

